

# Lounge-Anbau 2 für Malta 3

Art. Nr. 993400

1/8

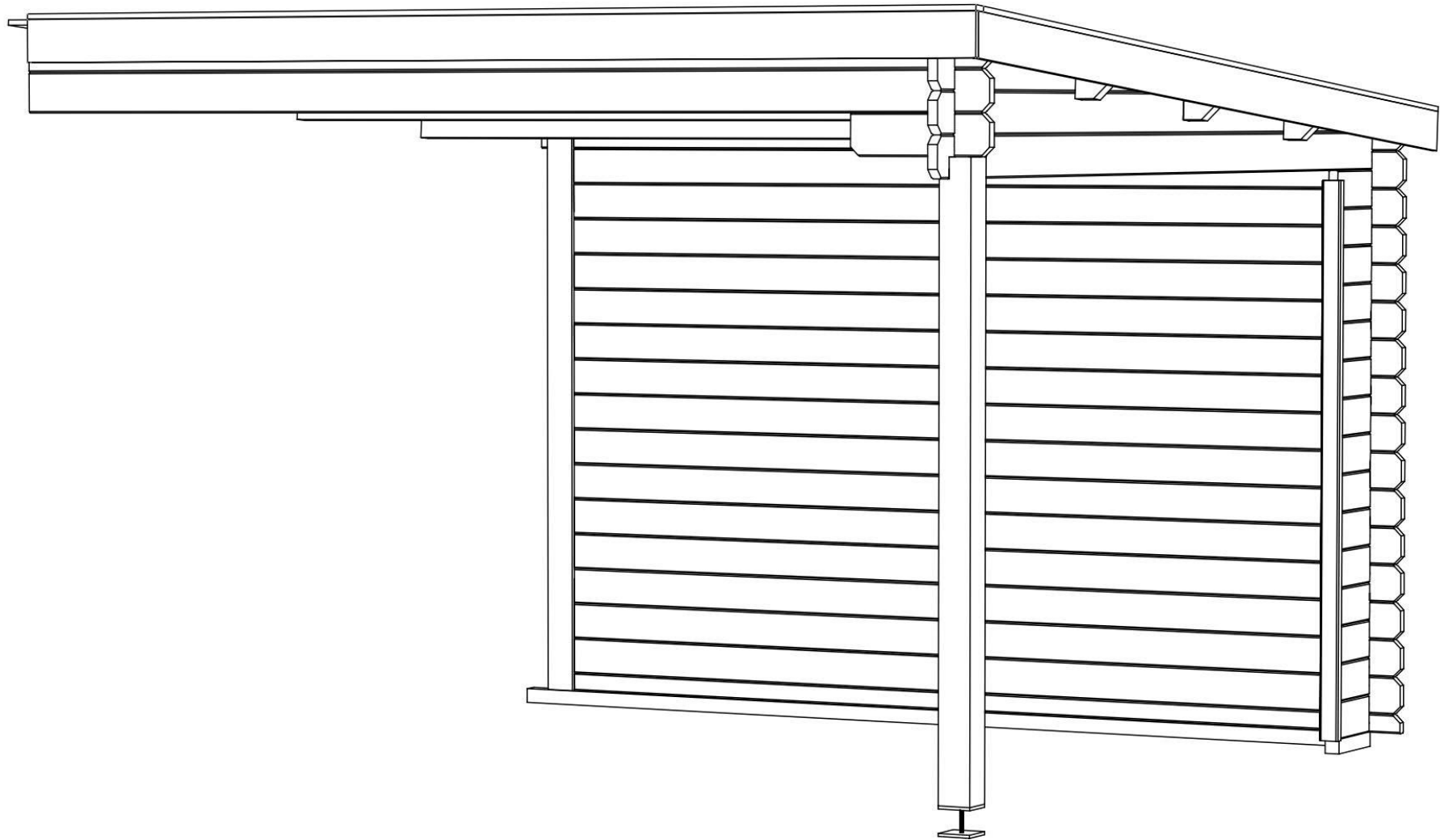

06.10.2017

Art. Nr. 993400

Groundplan - Grundplan - Plan de masse - Planimetria -  
Plattegrond - Põhiplaan

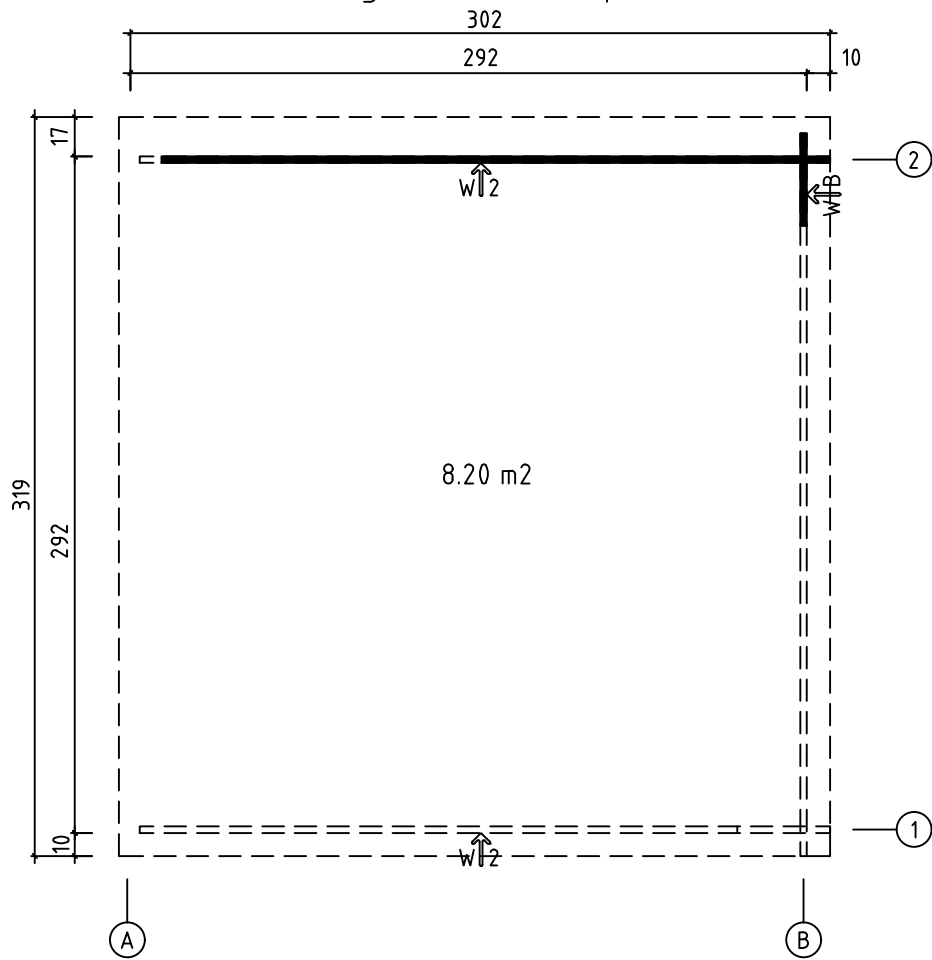

Foundation - Fundament - Fondation - Fondamenta - Fundering -  
Immutatud alusraam

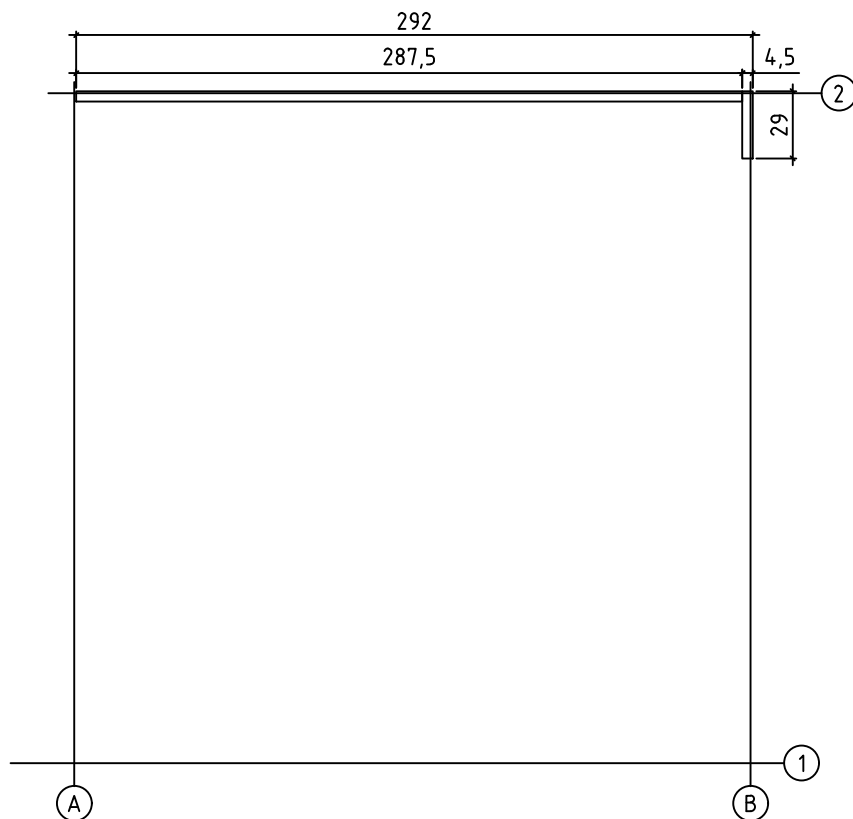



Art. Nr. 993400

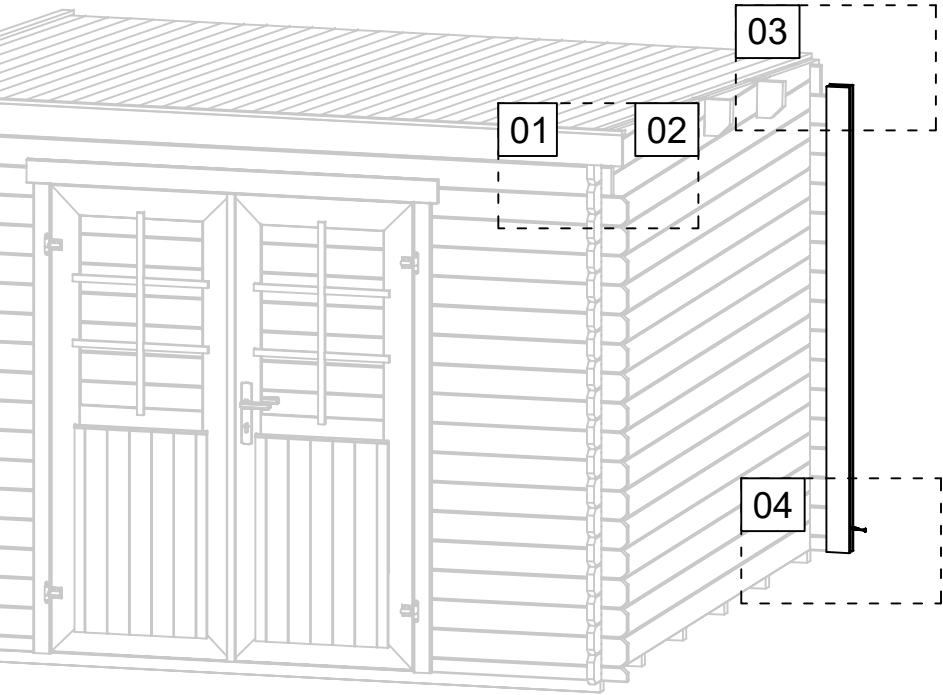

01

14

Malta 3  
TB

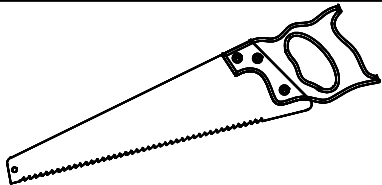

02

40

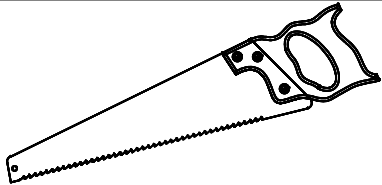

04

HP

HS13

06.10.2017

03

40

GL

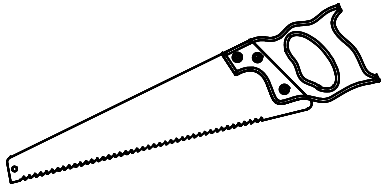

4/8

Art. Nr. 993400

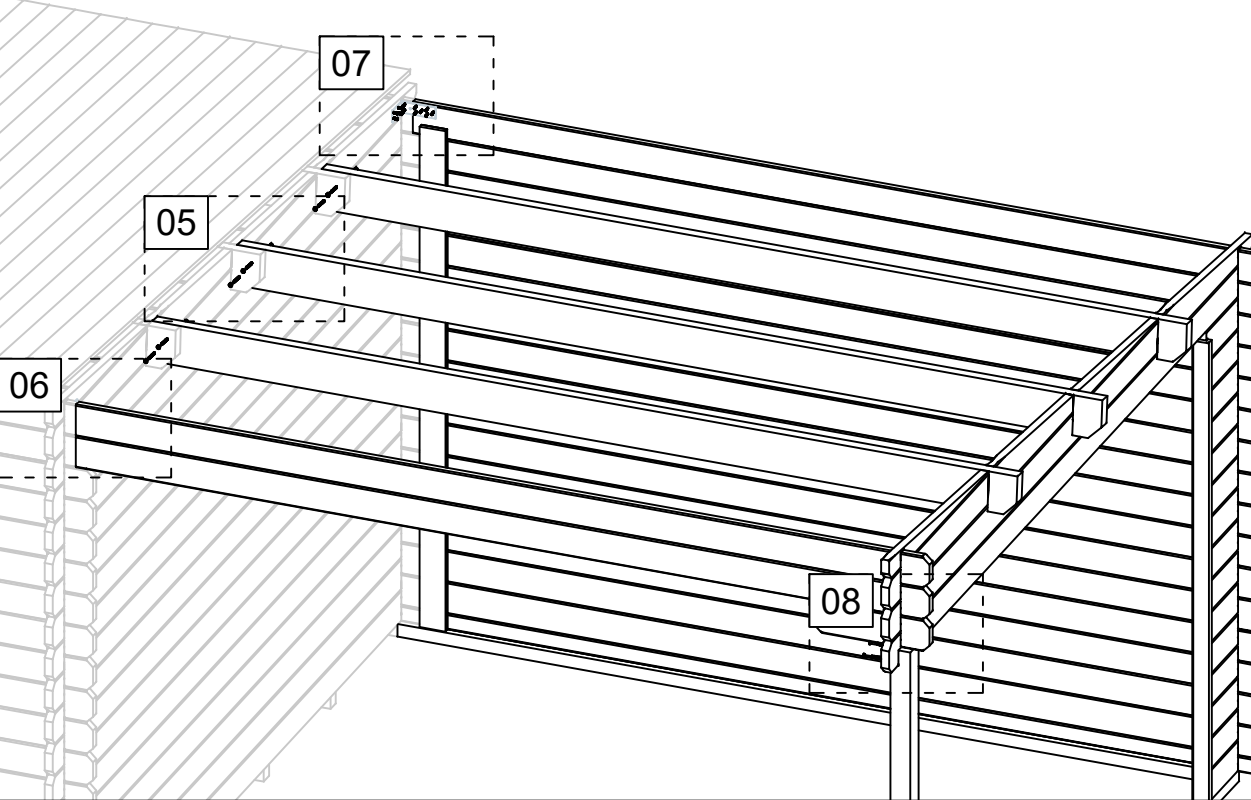

05

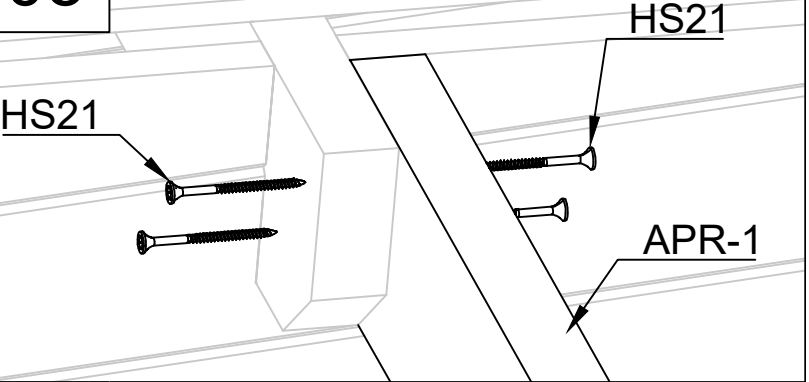

06

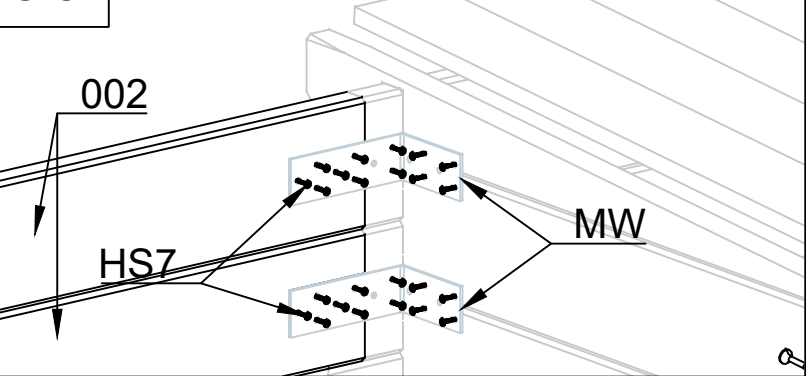

08

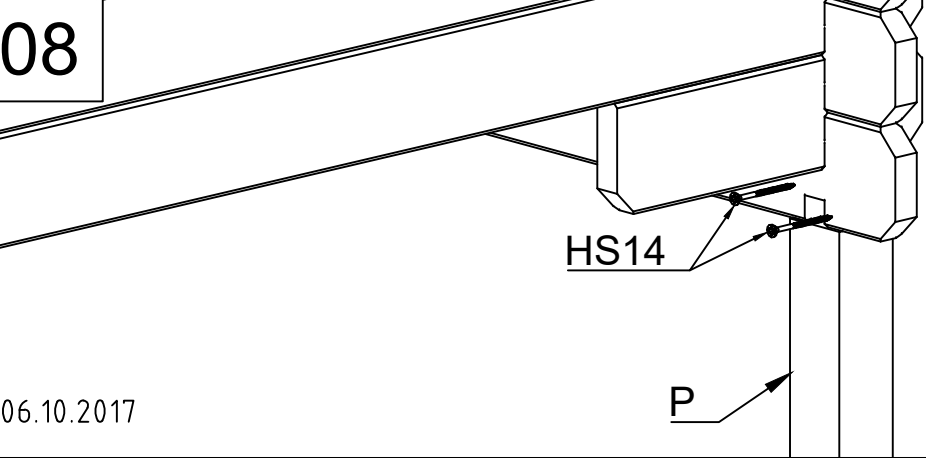

07

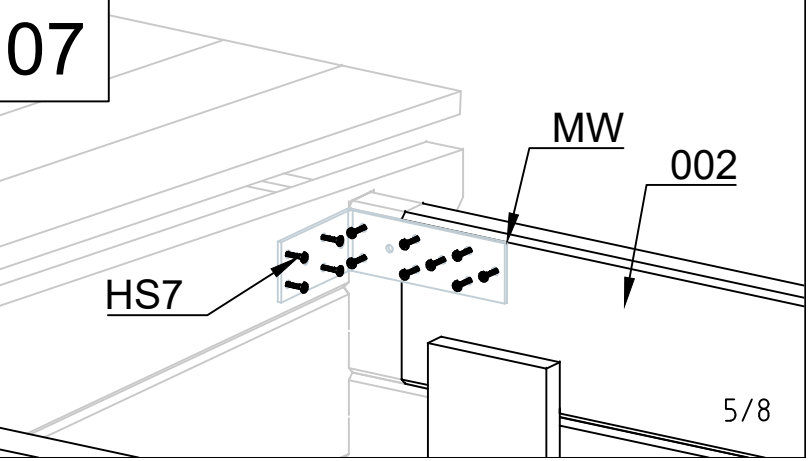

06.10.2017

5/8

Art. Nr. 993400

09

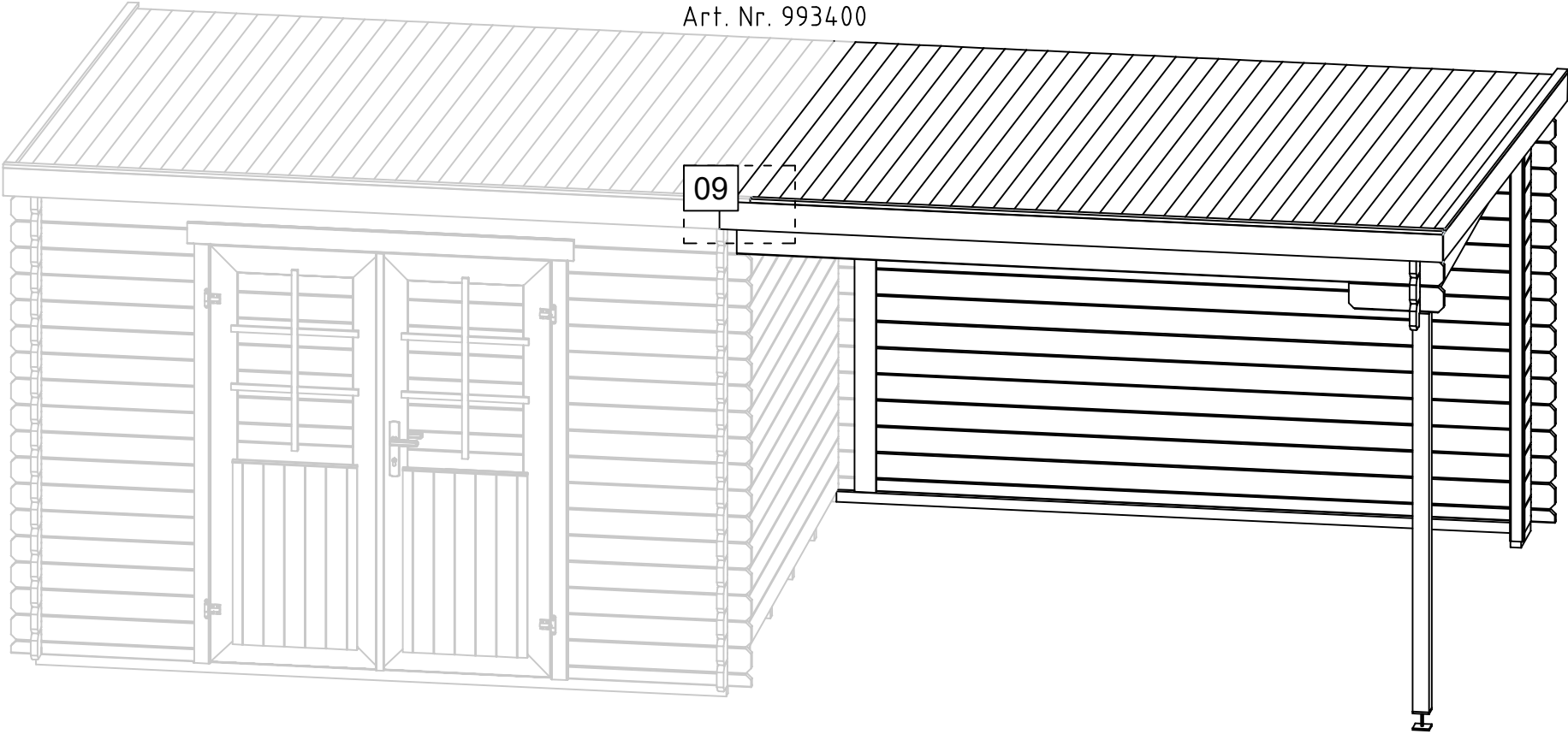









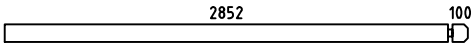
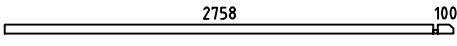
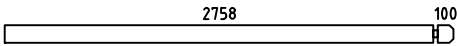

09

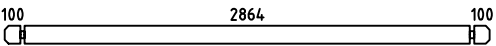
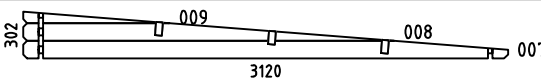
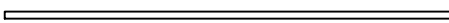
HS12

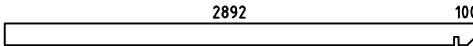
TB

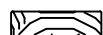
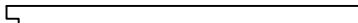
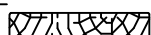
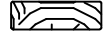
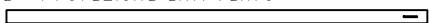
06.10.2017

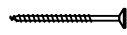
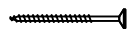
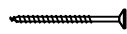
6/8

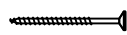
Pos	06.10.2017 Piece list - Stückliste - Liste des pièces - Elementi - Stuklijst - Tükitalabel Art. Nr. 993400 7/8	Q	P (mm)	L (mm)
001		1	28x114	400
002		3	28x114	2980
003		1	28x57	2886
004		15	28x114	2886
005		15	28x114	400
006		1	28x114	3120
WB-1		1		
IAR2	Foundation - Fundament - Fondation - Fondamenta - Fundering - Immutatud alusraam 	1	45x45	2875
IAR1	Foundation - Fundament - Fondation - Fondamenta - Fundering - Immutatud alusraam 	1	45x45	290
A-PR1	Roof beam - Dachbalken - Panne de toit - Perlina del tetto - Gordingen / dakbalk - Pärilin 	3	44x140	3020
	Roof boards - Dachbretter - Voliges - Perlina per tetto - Dakhout - Katuselaud 	35	90x15	3200
	Roofing felt fillet - Dachpappenleiste - Baguette de fixation du feutre bitumeux - Asse per fissaggio guaina bituminosa - Afdekljst asfaltpapier - Katusepapiilist 	1	15x45	2920
P	Post - Pfosten - Poteau - Piede registrabile - Stijl - Post 	1	70x70	1732
TB	Fascia board - Traufbrett - Bandeau de toit - Finitura lati tetto - Gevellijst - Räästalaud 	1	15x120	3049
DRV1	Roof edge reinforcement - Dachrandverstärkung - Corniere de renfort de bord de toit - Rinforzo x tetto - Dakrand versterking - Räästatugevdus 	1	15x45	2920
KFS-1	Storm protection - Sturmleiste - Latte anti-tempete - Protezione anti vento - Stormverankering / beveliging - Tormikinnitusliist 	1	22x45	2050
UP	U-profile - U-profils - Profile u - Profilo ad u - U-profiel - U-profiil 	1	28x58	1680
HP	H-profile - H-profils - Profile H - Profilo ad H - H-profiel - H-profiil 	1	58x90	1805
HS7	Screw for metal corner - Holzschraube für metallwinkel - Vis de fixation des cornieres en métal - Viti per fissare suadretta di metallo di giunzione - Schroef voor metalen hoek - Kruvi nurgikule 	36	2.5x20	
HS9	Screw for u-profile - Schraube zur befestigung u-profils - Vis a tete fraisée pour profil u - Vite per profilo ad u - Schroef ter bevestiging u-profiel - Kruvi U-profiilile 	3	3.5x50	
HS4	Screw for roof edge reinforcement - Schrauben für dachrandverstärkung - Vis pour fixation corniere renfort de bord de toit - Viti x rinforzo bordo tetto - Schroef voor dakrand versterking - Kruvi räästatugevdusele 	7	3x30	
HS14	Screw for post - Schrauben für pfosten - Vis de fixation des poteaux - Viti per inviare - Schroef voor stijlen - Kruvi postile 	2	4.5x80	
HS12	Screw for fascia boards - Schrauben für traufbretter - Vis pour fixation bandeau de toit - Viti x striscia del tetto - Schroef voor gevellijst - Kruvi räästalauale 	10	4x40	

